

DIMENSIONAL OUTLINE OF 2M246

DIMENSIONS IN MILLIMETERS

2M246-23TYPE

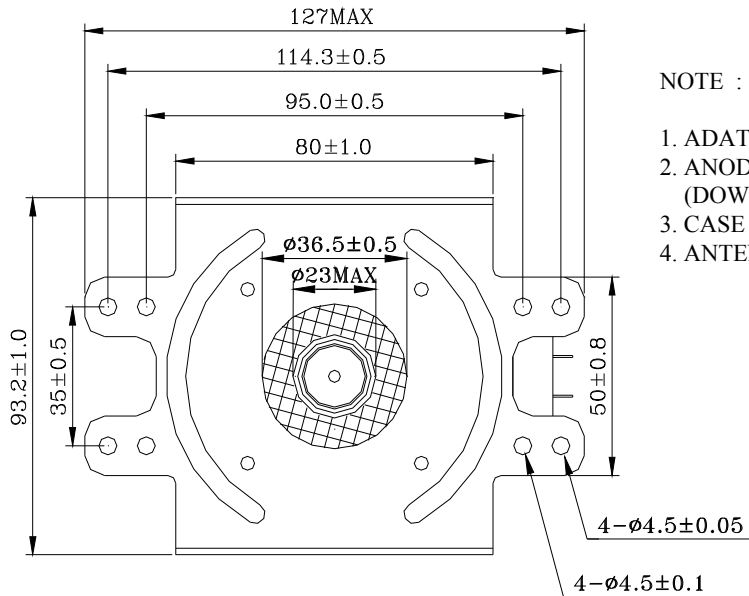

NOTE :

1. ADAPTABLE TO FASTON 250 SERIES RECEPTACLE.
2. ANODE TEMPERATURE MEASURING POINT.
(DOWN STREAM AIR)
3. CASE TEMPERATURE MEASURING POINT.
4. ANTENNA TEMPERATURE MEASURING POINT.

